

# CleversoundH XL 11000

## PARALELO GRAVES 8Ω

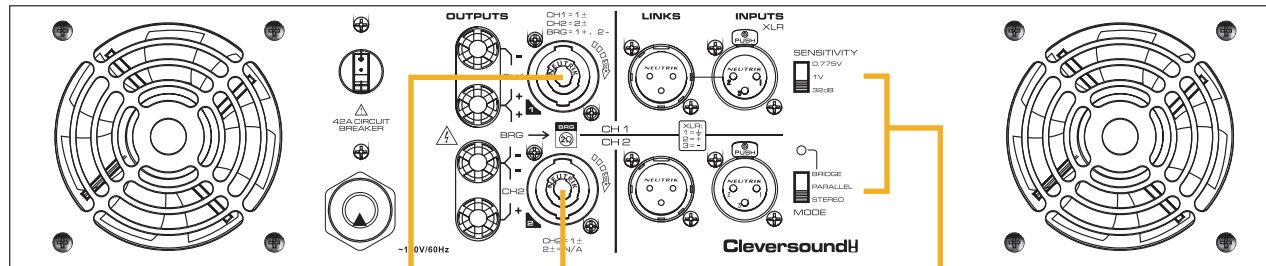

2 HILOS

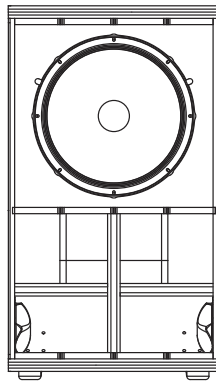

2 HILOS

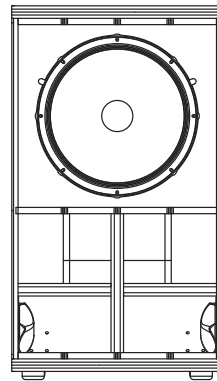

Configuración de pines

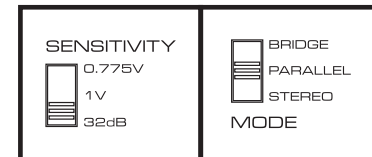

Sensibilidad  
32dB/2.3V

Modo  
Paralelo

8 Ohms  
2,000 Wrms por bocina  
**2,000 Wrms por canal**  
4,000 Wrms total

# CleversoundH XL 11000

## PARALELO GRAVES 4Ω

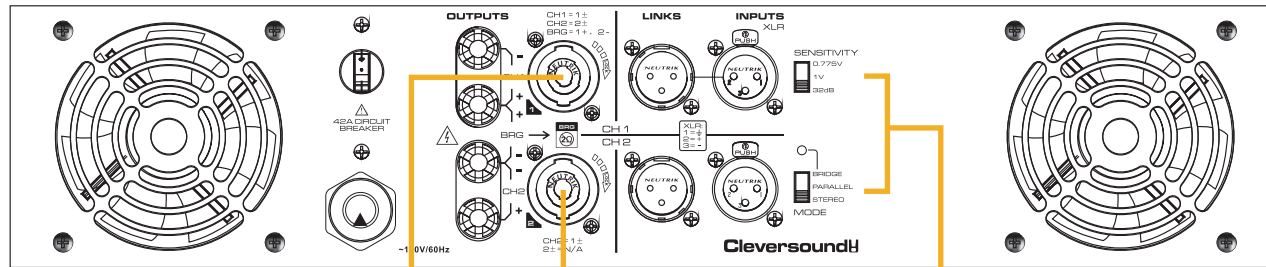

2 HILOS

2 HILOS

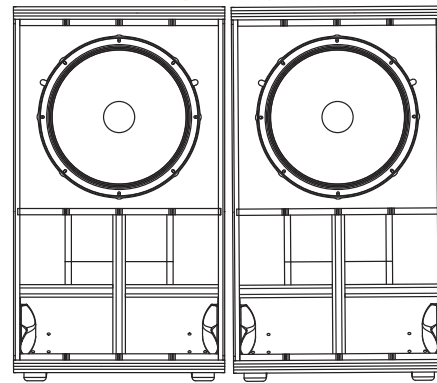
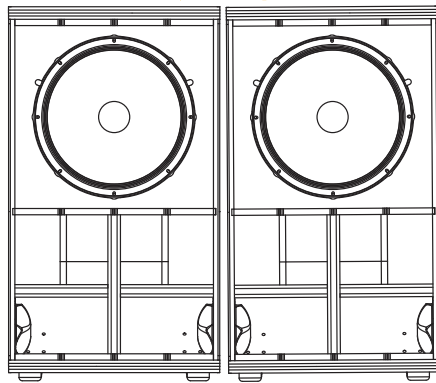

Configuración de pines

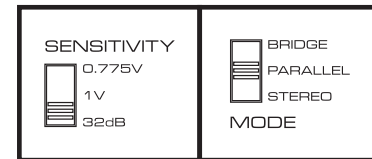

Sensibilidad  
32dB/2.3V

Modo  
Paralelo

4 Ohms  
1,750 Wrms por bocina  
**3,500 Wrms por canal**  
7,000 Wrms total

# CleversoundH XL 11000

## PARALELO GRAVES 2Ω

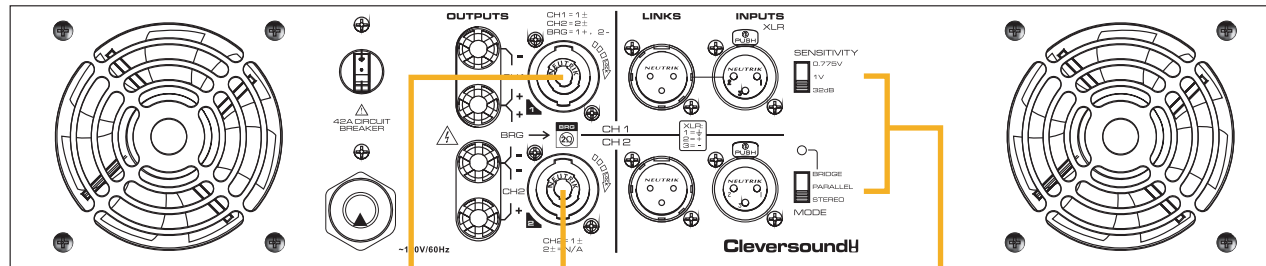

2 HILOS

2 HILOS

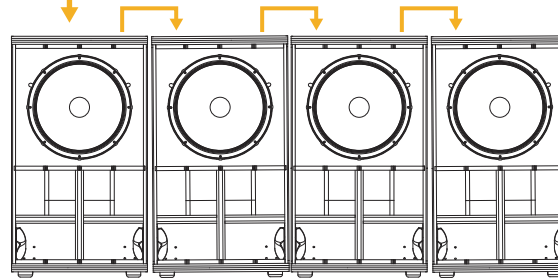
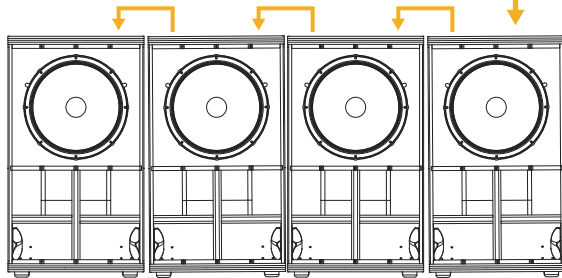

### Configuración de pines



Sensibilidad  
32dB/2.3V

Modo  
Paralelo

2 Ohms  
1,150 Wrms por bocina  
**4,600 Wrms por canal**  
9,200 Wrms total

# Cleversound<sup>U</sup> XL 11000

## PARALELO GRAVES 8Ω

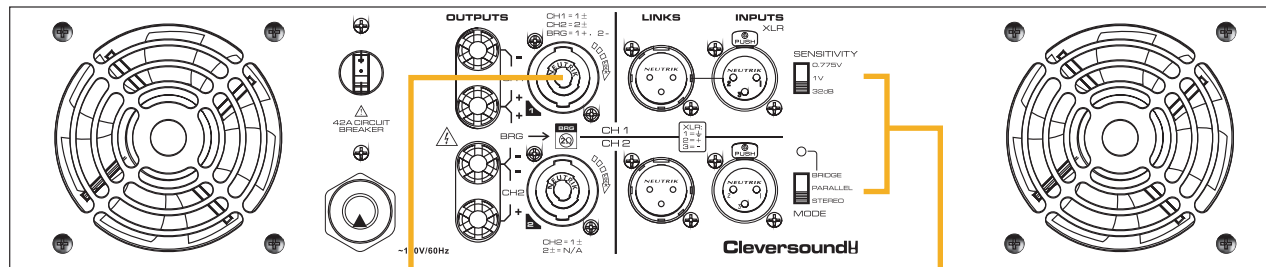

4 HILOS

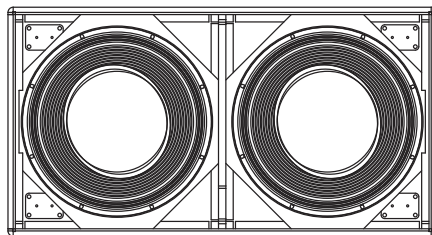

Conexión interna de los bafes

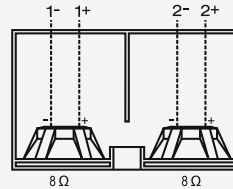

Configuración de pines

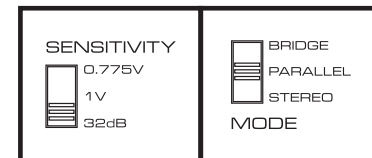

Sensibilidad  
32dB/2.3V

Modo  
Paralelo

8 Ohms  
2,000 Wrms por bocina  
**2,000 Wrms por canal**  
4,000 Wrms total

# Cleversound<sup>®</sup> XL 11000

## PARALELO GRAVES 4Ω

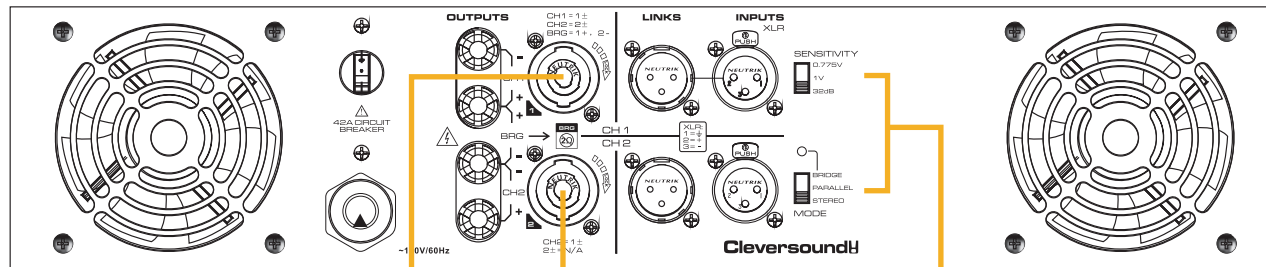

4 HILOS

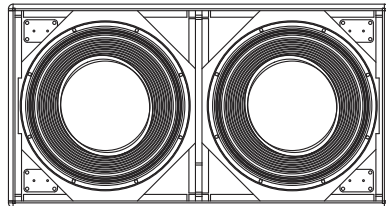

4 HILOS

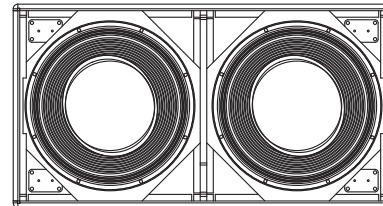

Conexión interna de los bafles

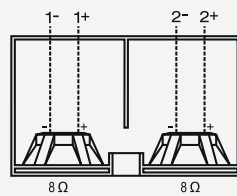

Configuración de pines

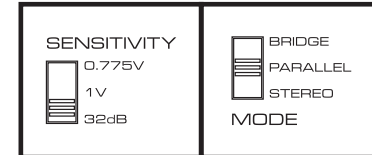

Sensibilidad  
32dB/2.3V

Modo  
Paralelo

4 Ohms  
1,750 Wrms por bocina  
**3,500 Wrms por canal**  
7,000 Wrms total

# Cleversound<sup>H</sup> XL 11000

## PARALELO GRAVES 2Ω

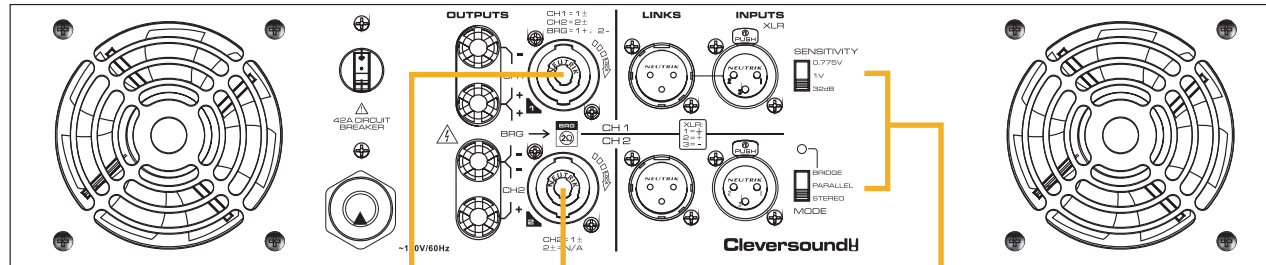

4 HILOS

4 HILOS

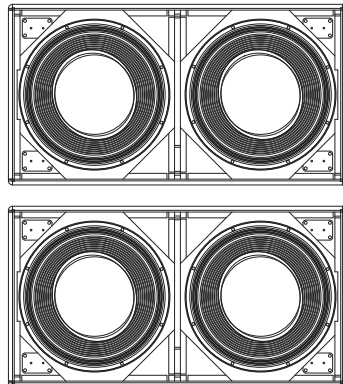

4 HILOS

Conexión interna de los bafles

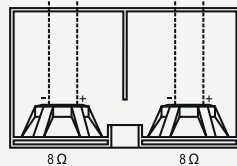

4 HILOS

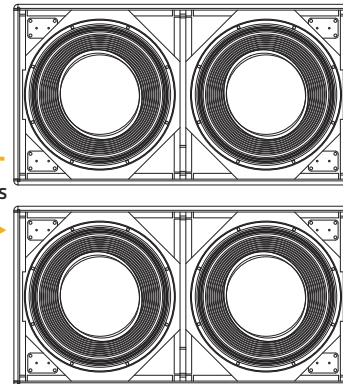

Configuración de pines

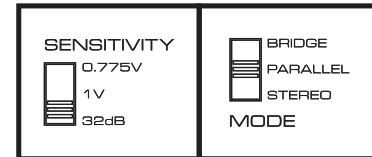

Sensibilidad  
32dB/2.3V

Modo  
Paralelo

2 Ohms  
1,150 Wrms por bocina  
**4,600 Wrms por canal**  
9,200 Wrms total